

# SERVICE MANUAL



# FISHER

COMPACT DISC AUDIO  
COMPONENT SYSTEM WITH  
WIRELESS REMOTE CONTROL  
RTAD-M90

## TAD-M90

( EUROPE )



132 357 40

## SPECIFICATIONS

### Tuner Section

#### FM

Frequencies received ..... 87.50 ~ 108.00 MHz  
DIN practical sensitivity (mono) ..... 1.2  $\mu$ V  
S/N ratio ..... 70 dB (mono, 1 mV, 40K DEV.)  
Harmonic distortion ..... 0.1 % (mono, 1 kHz)  
Stereo separation ..... 40 dB (1 kHz)  
Image frequency interference ratio ..... 70 dB

#### MW

Frequencies received ..... 522 ~ 1611 kHz  
Practical sensitivity ..... 700  $\mu$ V/m  
S/N ratio ..... 55 dB  
Image frequency interference ratio ..... 35 dB  
Selectivity ..... 35 dB  
IF interference ratio ..... 65 dB

#### LW

Frequencies received ..... 153 ~ 360 kHz  
Practical sensitivity ..... 1600  $\mu$ V/m  
S/N ratio ..... 53 dB  
Image frequency interference ratio ..... 48 dB  
Selectivity ..... 40 dB  
IF interference ratio ..... 65 dB

### Amplifier Section

Output power (Front) ..... 25 W (T.H.D 0.9 %)  
Input sensitivity/impedance  
PHONO ..... 2.5 mV/50 k $\Omega$   
AUX ..... 150 mV/50 k $\Omega$

### DECK Section

Motor ..... DC motor (DECK 1 and DECK 2)  
Head ..... Hi-B hard permalloy head  
(DECK 1 playback head, DECK 2 recording head)  
Ferrite head (DECK 2 erasing head)  
Fast-forward/rewind time ..... Approx. 110 sec. (C-60 tape)  
Tracks ..... 4-track, 2-channel stereo  
S/N ratio (playback) ..... 50 dB  
Frequency response ..... 40 Hz ~ 14 kHz (metal tape)  
Wow and flutter ..... 0.16 % (JIS UNWTD)

### CD Player Section

Frequency response ..... 20 Hz ~ 20 kHz  
Harmonic distortion ..... Less than 0.04 % (1 kHz)  
S/N ratio ..... 95 dB  
Wow and flutter ..... Below measurable limits  
Optical pickup ..... 3-beam laser  
Error correction ..... CIRC  
Sampling frequency ..... 44.1 kHz  
D/A conversion ..... 16-bit linear  
Filter ..... 8 Times Over Sampling Digital filter

### General

Power requirements ..... AC: 220 V, 50 Hz  
Power consumption ..... 150 W  
Dimensions (WxHxD) ..... 360 x 355 x 309 mm  
Weight (approx.) ..... 8.2 kg

Dolby is a registered trademark of Dolby Laboratories Licensing Corporation.

— Specifications and design are subject to change without notice. —

REFERENCE No. WM-570538

# SCHEMATIC DIAGRAM

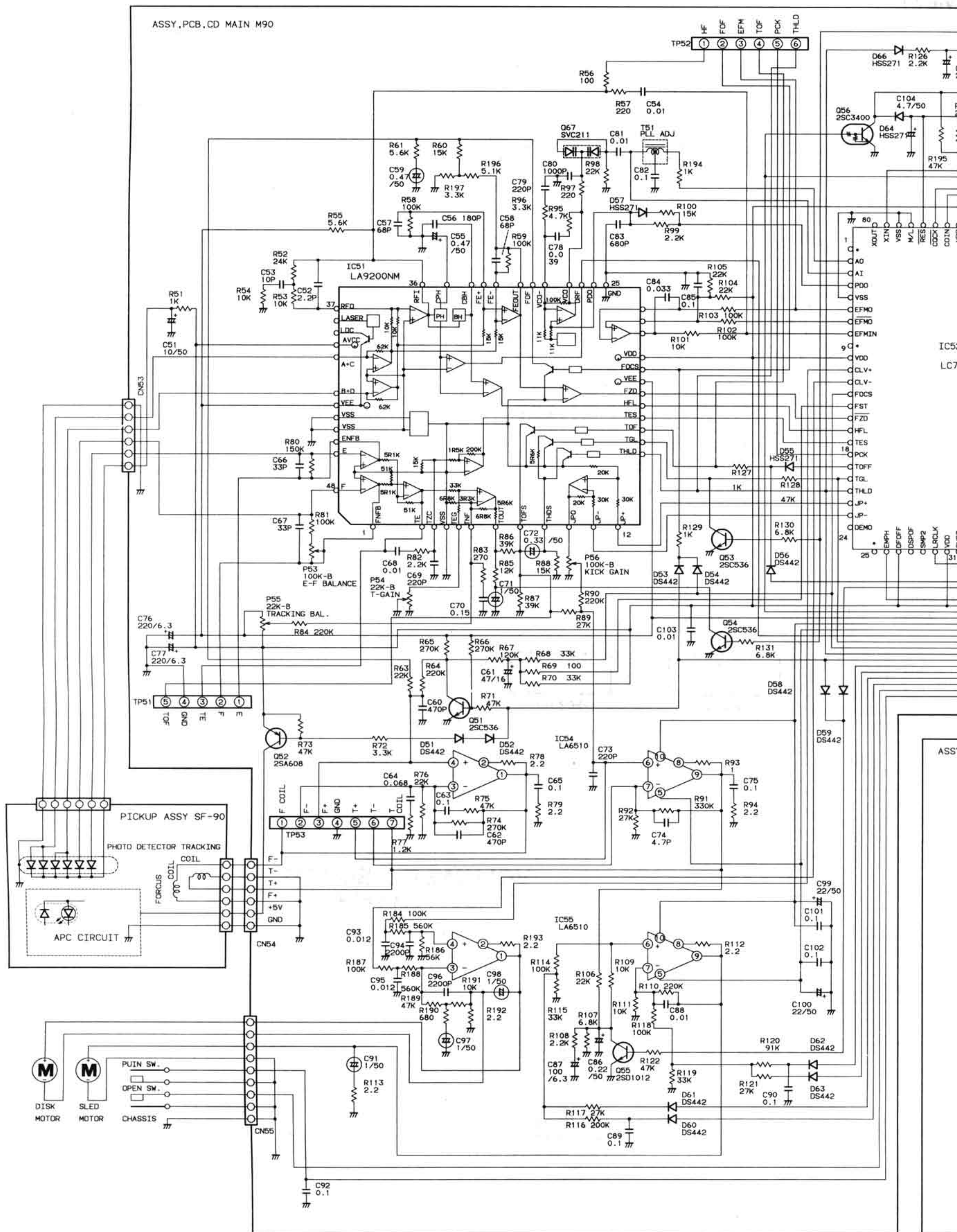

# AGRAM (CD Main/Control Section)

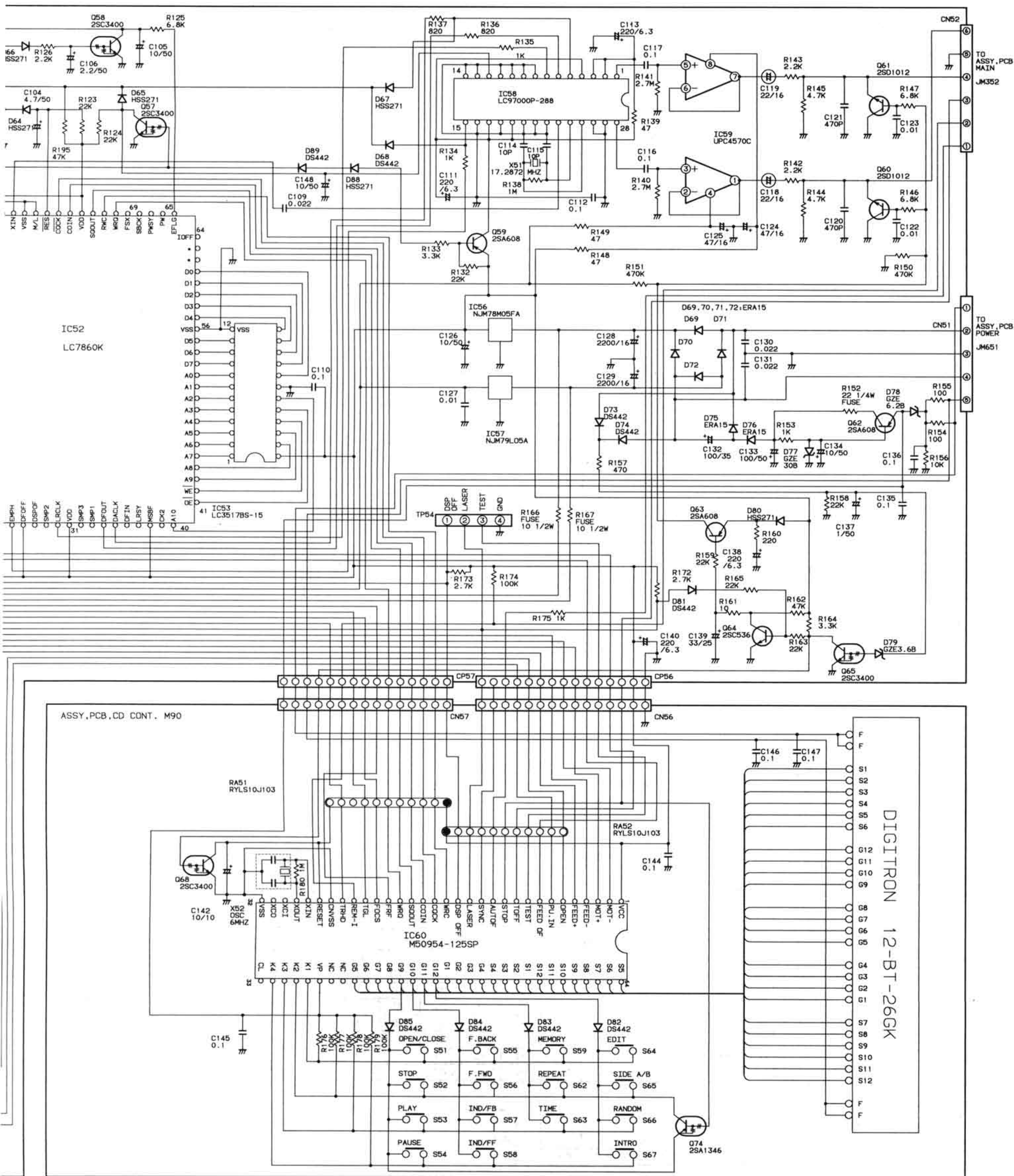

# SCHEMATIC DIAGRAM

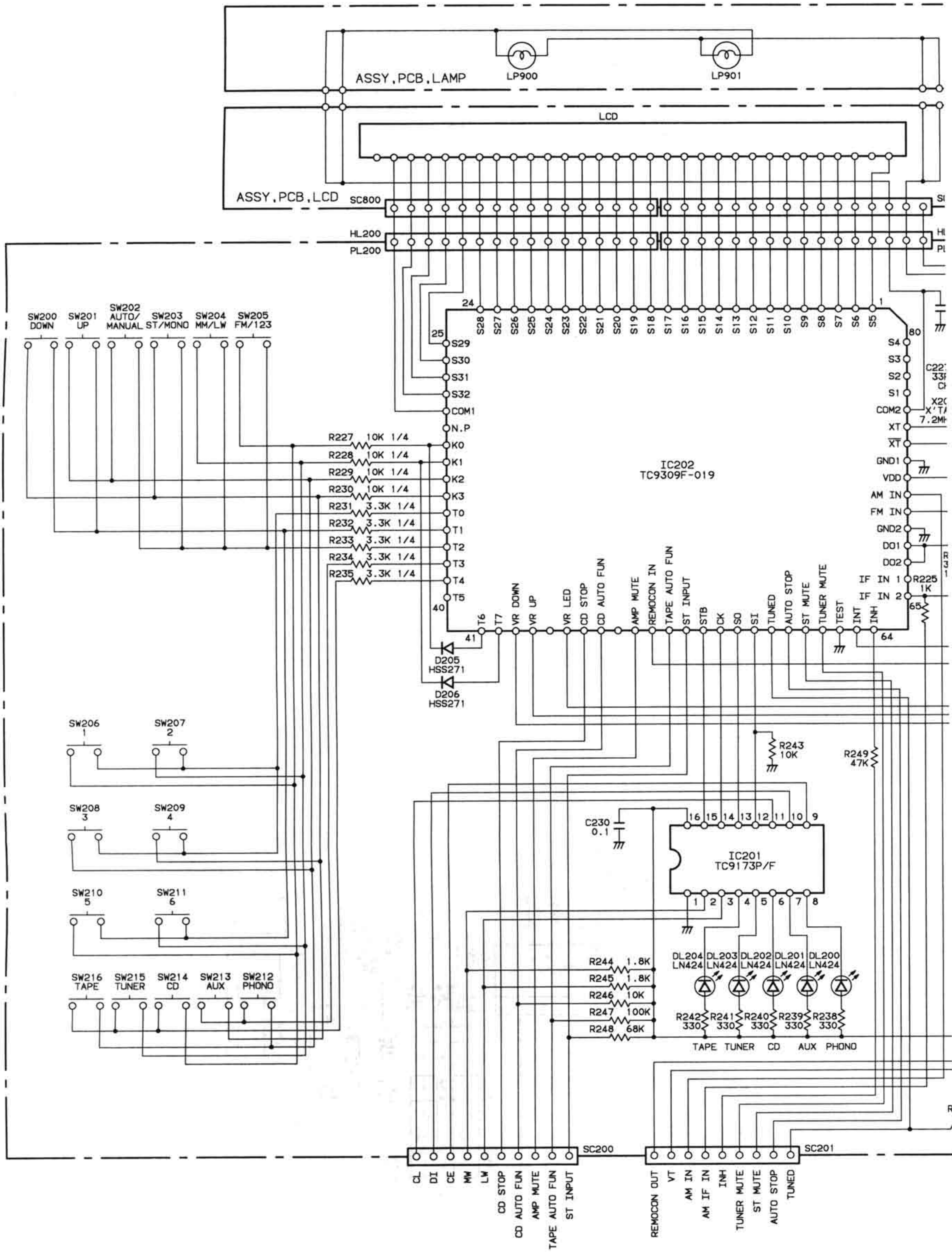

# GRAM (Amplifier Control Section)

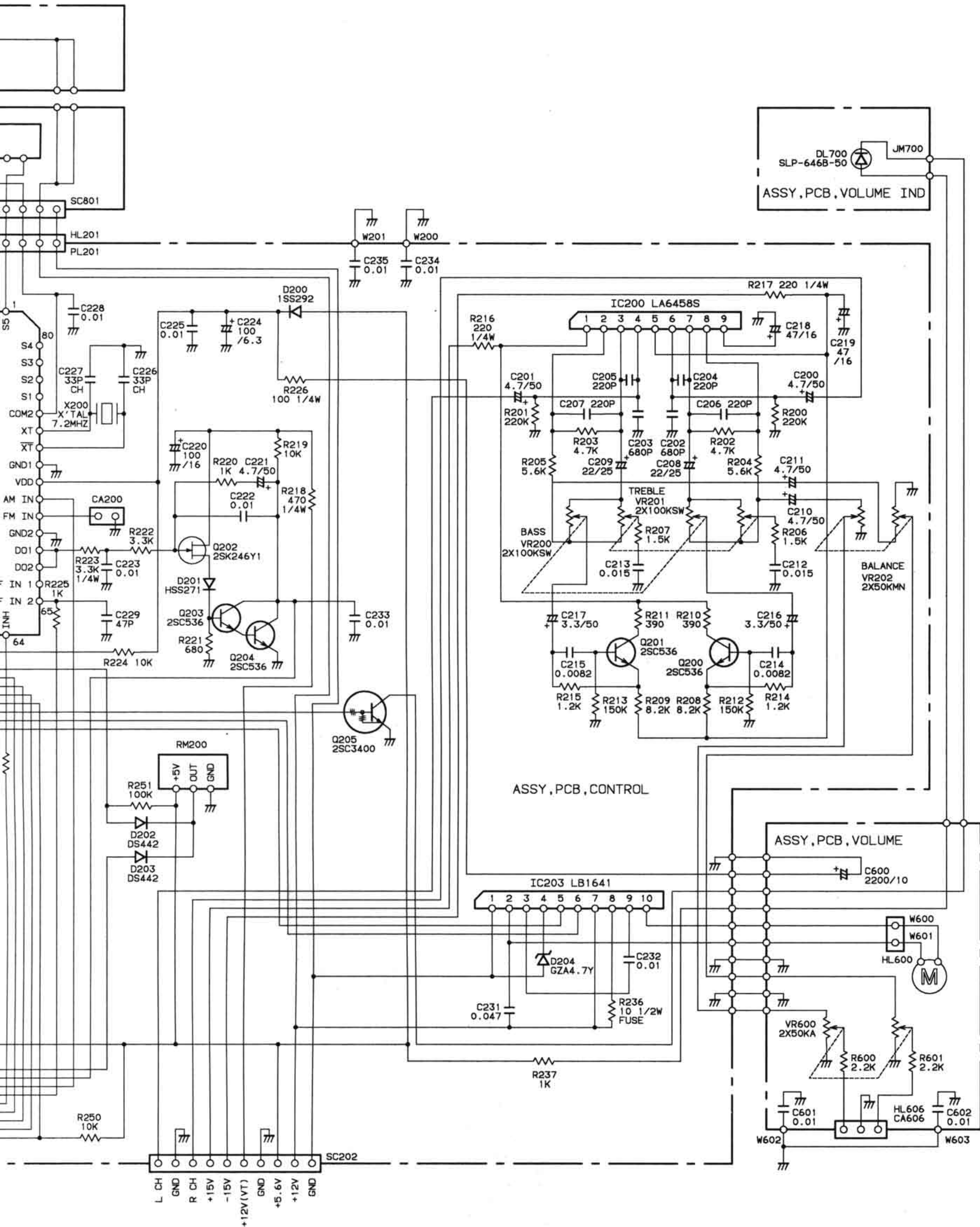

# SCHEMATIC DIAGR

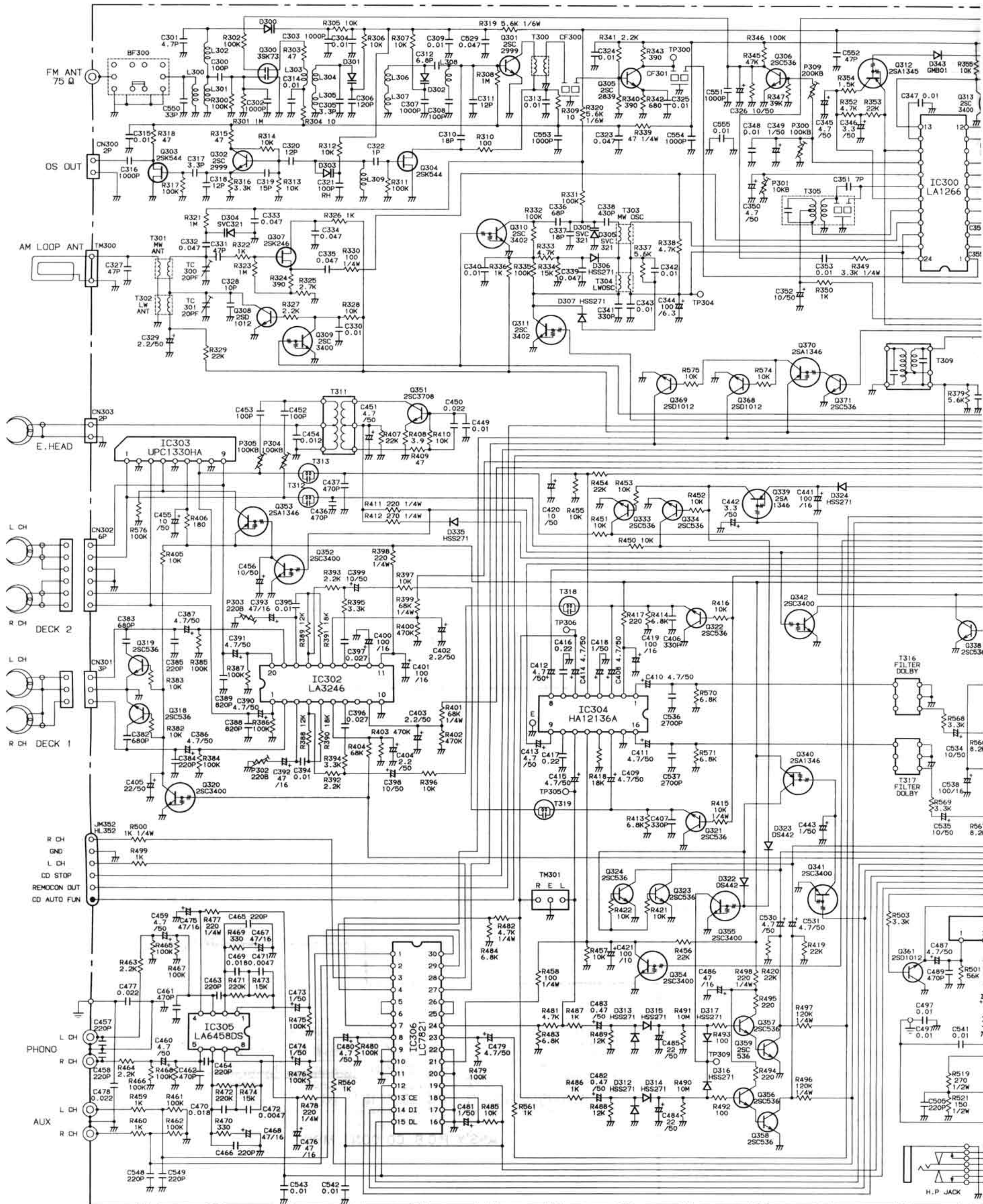

## NOTES:

1. All resistors are 1/4 watt or 1/6 watt 5% unless marked. Otherwise Resistor values are in ohms (K=1000 ohms, M=100k ohms).
2. All capacitor values are in microfarads. (P = picofarads).

# C DIAGRAM (Main unit Section)

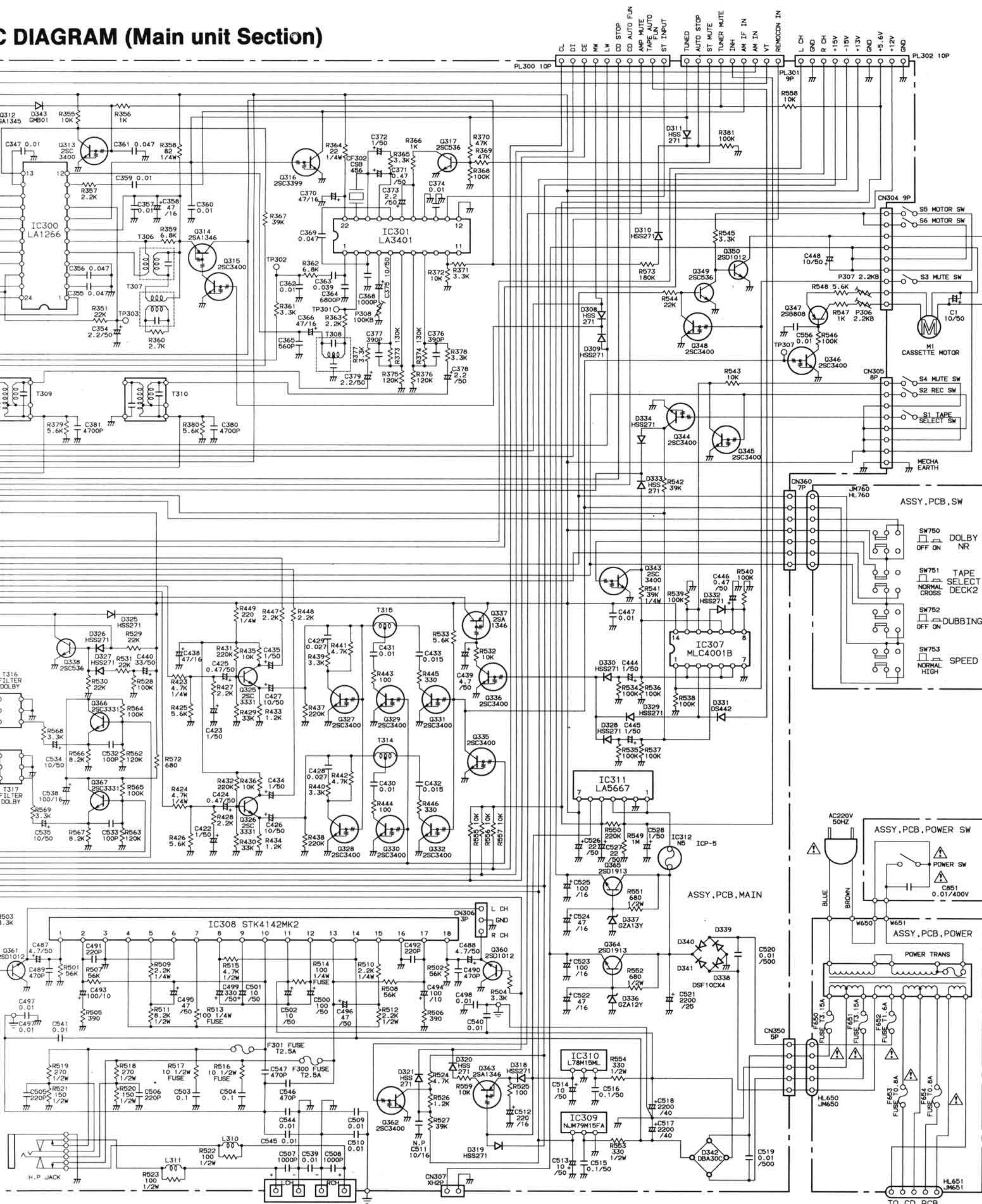

1. Components marked with a triangle symbol are Safety Parts. Use only replacement parts recommended by the manufacturer.
2. This is a basic schematic diagram.

# WIRING DIAGRAM

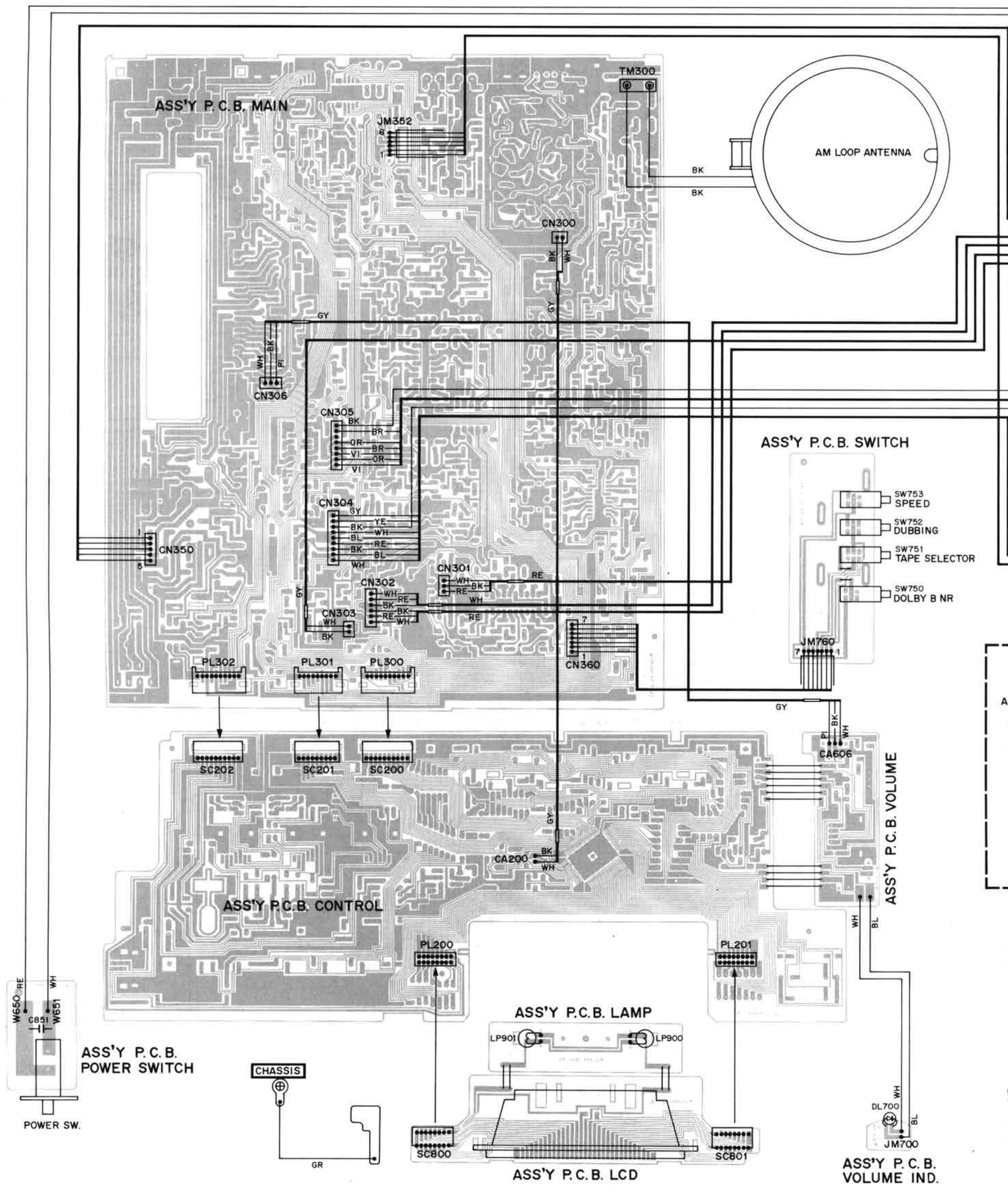



# DIAGRAM

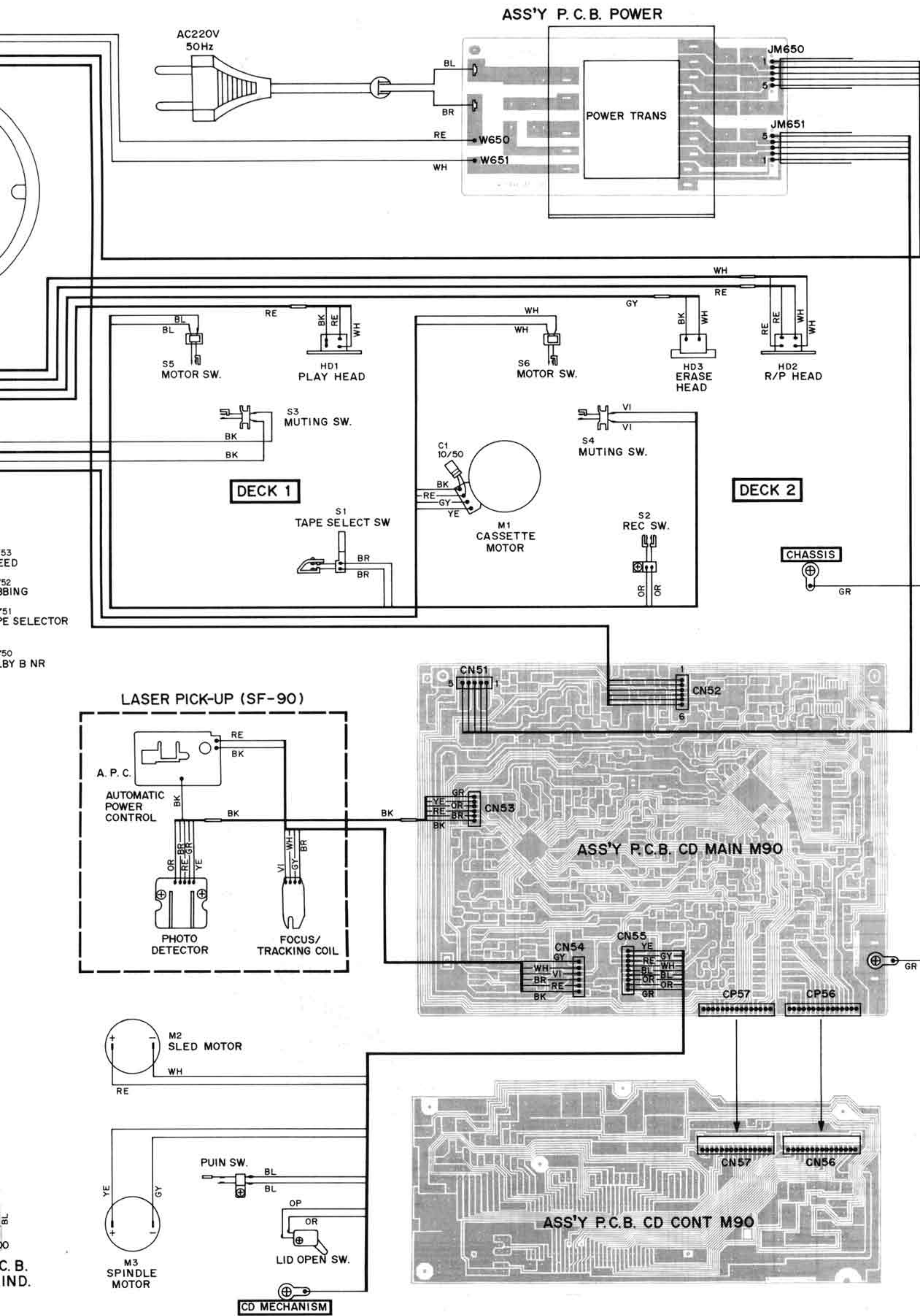

53  
EED

52  
BBING

51  
PE SELECTOR

50  
BY B NR

BL

00

C. B.

IND.